



REVERSIBLE TIME TRAVEL WITH FREEDOM OF CHOICE

The Time Machine Factory 2019

Turin

September 24, 2019

Ämin Baumeler



Based on: „Reversible Time Travel with Freedom of Choice,“
arXiv:1703.00779 [gr-qc]

(provisionally accepted to Classical and Quantum Gravity)

joint work with

Fabio Costa



Timothy C. Ralph



Stefan Wolf



Magdalena Zych



DISCLAIMER

- Highly inspired by:
O. Orshkov, F. Costa, Č. Brukner, „*Quantum correlations with no causal order*,“ Nat. Comm **3**, 1092 (2012)
- Nothing quantum / no quantum features!
- Not formulated in the GR language / no specific type of systems (billiard balls, fields, *etc.*)
Instead: Abstract formalism for classical and deterministic dynamics.
- Very subtle CTCs; maybe not what you expect.

OUTLINE

- Motivation / Historical background
- Consistency condition and „no new physics“ principle
- Our approach
- Properties of CTCs
- Example

MOTIVATIONS

- Closed time-like curves are consistent with general relativity:

Die formale Grundlage der allgemeinen Relativitätstheorie.

VON A. EINSTEIN.

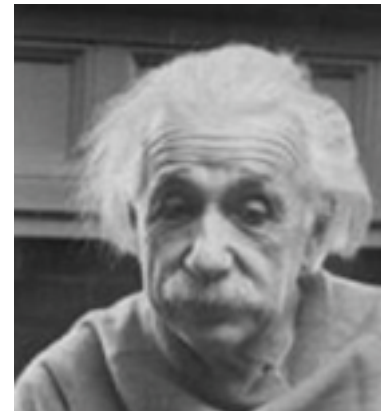

Über eine stationäre Kosmologie im Sinne der Einsteinschen Gravitationstheorie.

VON KORNEL LANZOS in Freiburg i. B.

Mit vier Abbildungen. (Eingegangen am 13. November 1923.)

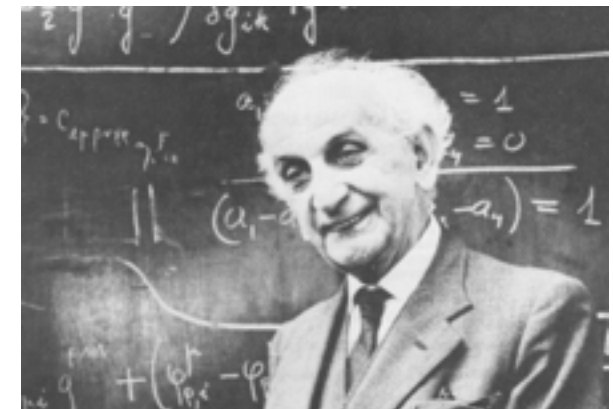

REVIEWS OF MODERN PHYSICS

VOLUME 21, NUMBER 3

JULY, 1949

An Example of a New Type of Cosmological Solutions of Einstein's Field Equations of Gravitation

KURT GÖDEL
Institute for Advanced Study, Princeton, New Jersey



EINSTEIN (1914)

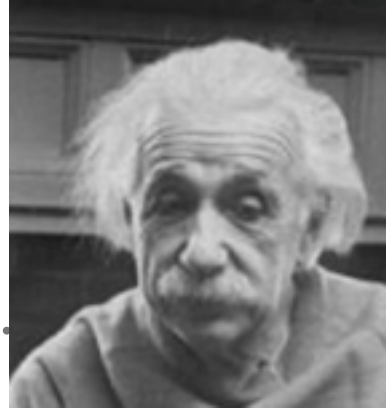

Eine noch tiefer gehende Frage von fundamentaler Bedeutung, deren Beantwortung mir nicht möglich ist, soll nun aufgeworfen werden. In der gewöhnlichen Relativitätstheorie ist jede Linie, welche die Bewegung eines materiellen Punktes beschreiben kann, d. h. jede aus nur zeitartigen Elementen bestehende Linie, notwendig eine ungeschlossene; denn eine solche Linie besitzt niemals Elemente, für die dx_4 verschwindet. Das Entsprechende kann in der hier entwickelten Theorie nicht behauptet werden. **Es ist daher a priori eine Punkt-bewegung denkbar, bei welcher die vierdimensionale Bahnkurve des Punktes eine fast geschlossene wäre. In diesem Falle könnte ein und derselbe materielle Punkt in einem beliebig kleinen raum-zeitlichen Gebiete in mehreren voneinander scheinbar unabhängigen Exemplaren vorhanden sein.** Dies widerstrebt meinem physikalischen Gefühl aufs lebhafteste. Ich bin aber nicht imstande, den Nachweis zu führen, daß das Auftreten solcher Bahnkurven nach der entwickelten Theorie ausgeschlossen sei.

EINSTEIN (1914)

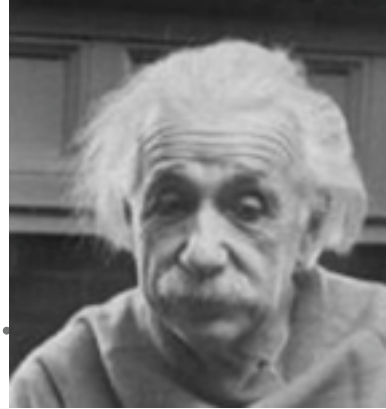

Eine noch tiefer gehende Frage von fundamentaler Bedeutung, deren Beantwortung mir nicht möglich ist, soll nun aufgeworfen werden. In der gewöhnlichen Relativitätstheorie ist jede Linie, welche die Bewegung eines Punktes in einem Gebiet, d. h. jede Kurve, die aus nur zeitlich geschlossenen Elementen besteht, für die Theorie nicht ausgeschlossen. Ich bin aber nicht imstande, den Nachweis zu führen, daß das Auftreten solcher Bahnkurven nach der entwickelten Theorie ausgeschlossen sei.

1916:
Two letters to Carathéodory
(remained unanswered)

eine Punkt-
bahnkurve des
Raumes ein und
am-zeitlichen
abhängigen
em physika-

GÖDEL (1949)

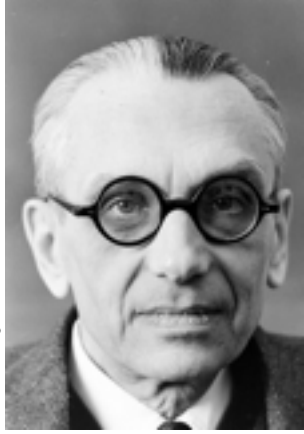

(6) Every world line of matter occurring in the solution is an open line of infinite length, which never approaches any of its preceding points again; but there also exist closed time-like lines.³ In particular, if P, Q are any two points on a world line of matter,⁴ and P precedes Q on this line, there exists a time-like line connecting P and Q on which Q precedes P ; i.e., it is theoretically possible in these worlds to travel into the past, or otherwise influence the past.

EXAMPLE OF CTC

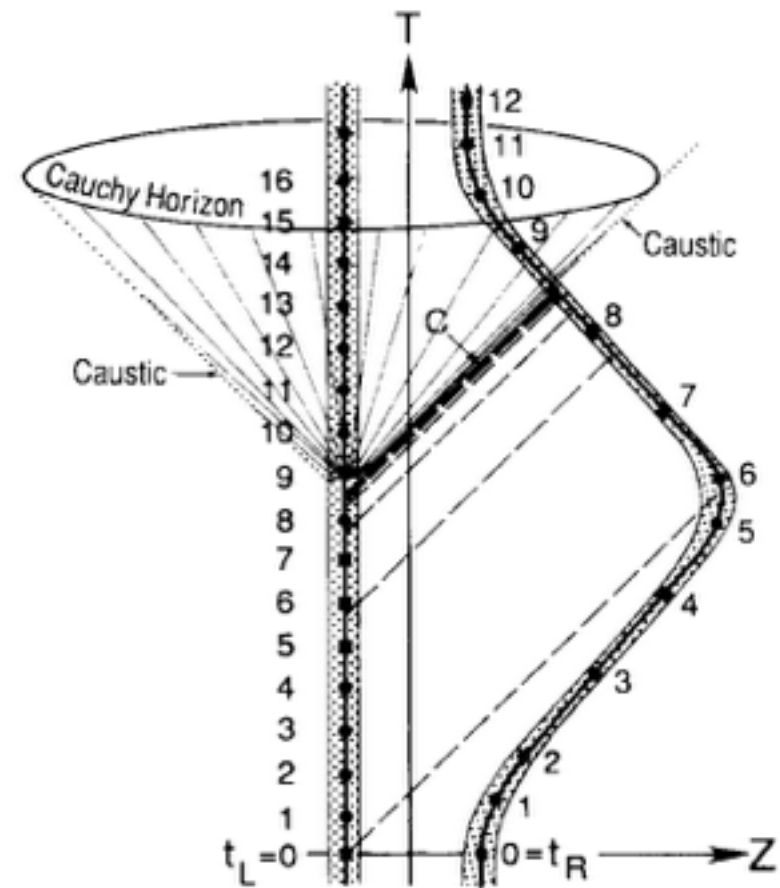

FIG. 2. Spacetime diagram for conversion of a wormhole into a time machine.

PRINCIPLE OF SELF-CONSISTENCY AND „NO NEW PHYSICS“

- The Self-Consistency Principle:
Only self-consistent solutions occur.
- Yet, there is more to that.
The „No New Physics“ Principle:

is intended to rule out such behavior. It insists that local physics is governed by the same types of physical laws as we deal with in the absence of CTC's: laws that entail

self-consistent single valuedness for the fields. In essence, the principle of self-consistency is a principle of no new physics. If one is inclined from the outset to ignore or discount the possibility of new physics, then one will regard self-consistency as a trivial principle.

NO NEW PHYSICS AND BILLIARD BALLS

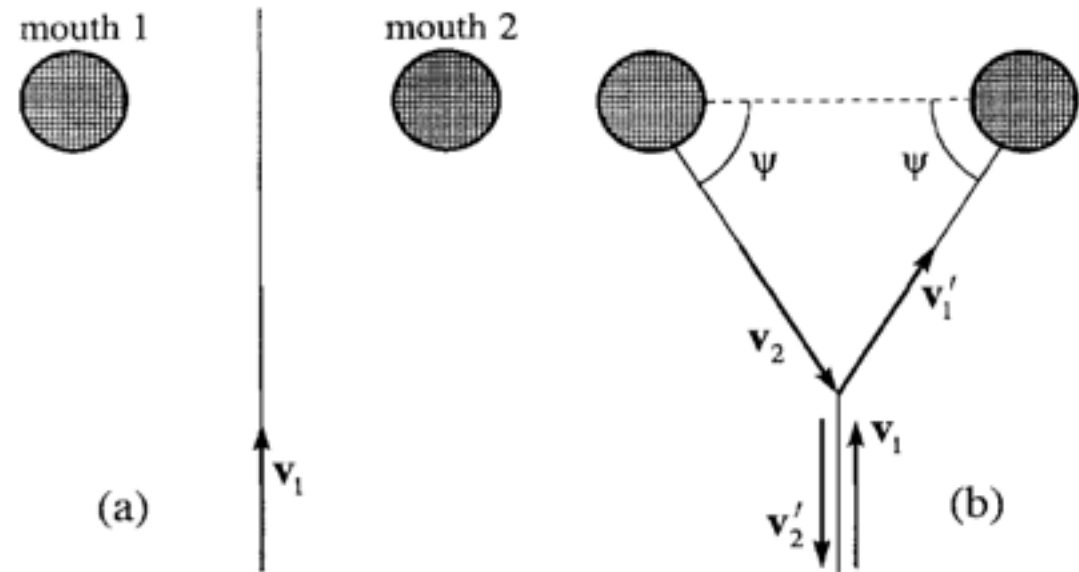
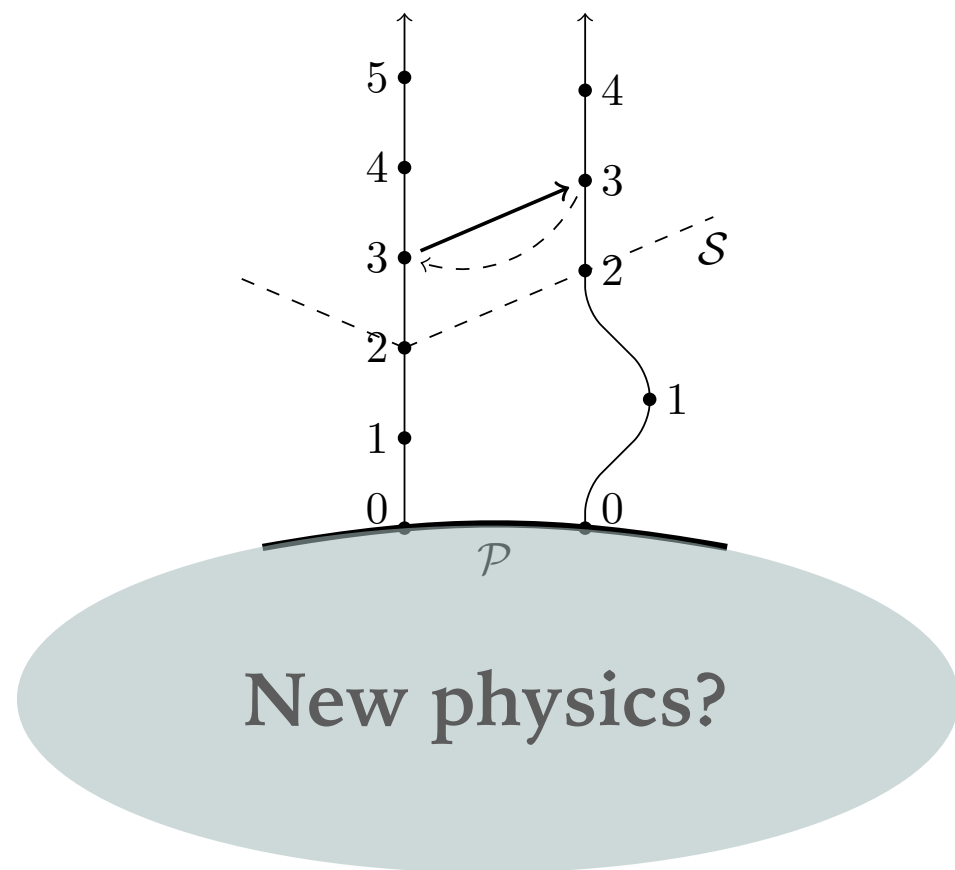

through the wormhole and thereby back in time, and then sends the ball into collision with itself. In contrast with one's naive expectation that dangerous trajectories might have multiplicity zero and thereby make the Cauchy problem ill posed ("no solutions"), it is shown that *all* dangerous initial trajectories in a wide class have *infinite* multiplicity and thereby make the Cauchy problem ill posed in an unexpected way: "far too many solutions." The wide class of infinite-multiplicity, dangerous

OUR APPROACH

- Assume the principle *not only in the past of CTCs*, but also in localized space-time regions that are traversed.

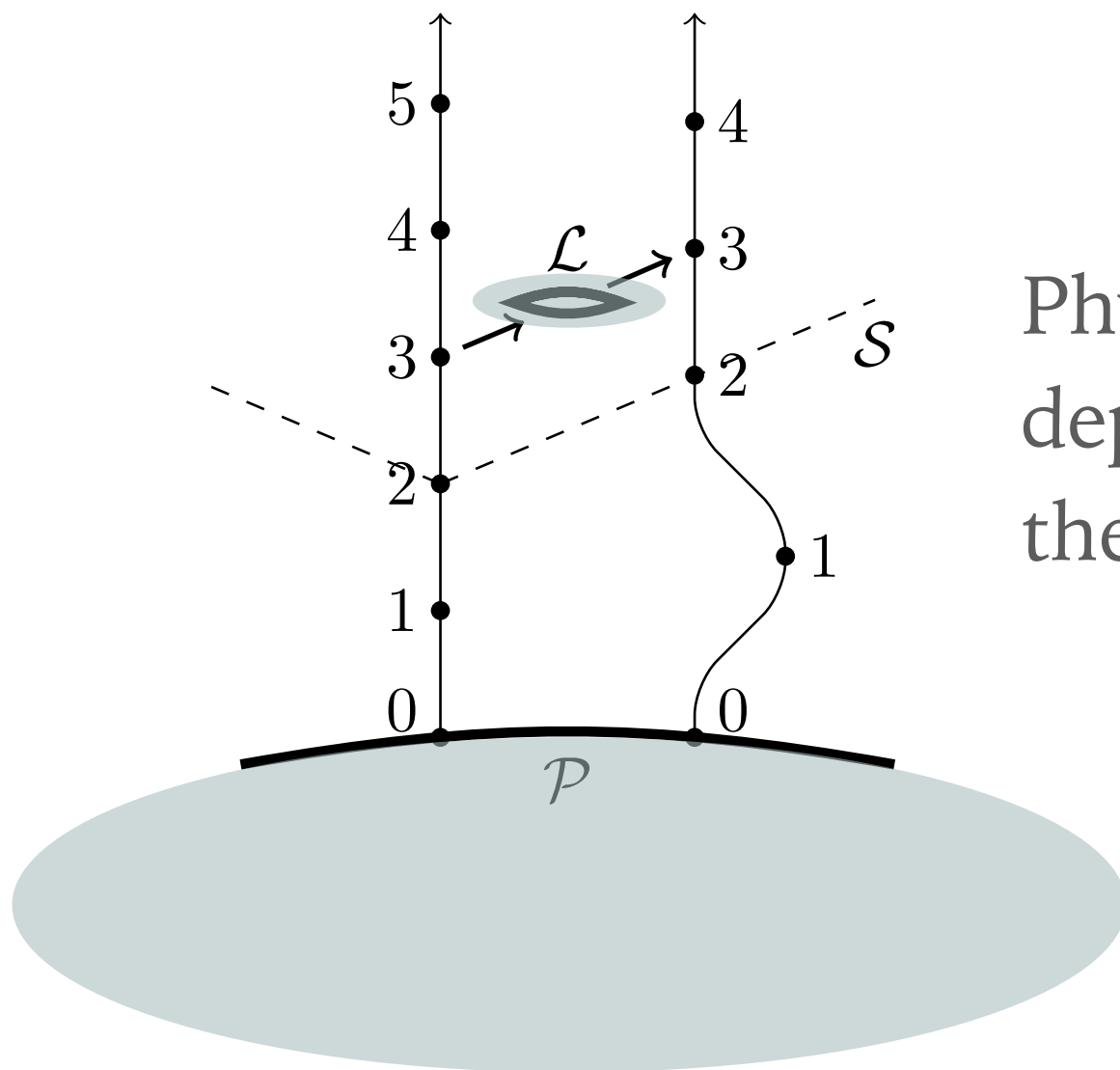

Physics within L and at P does not depend on the presence or absence of the CTC.

DISCLAIMER

- Highly inspired by:
O. Orshkov, F. Costa, Č. Brukner, „*Quantum correlations with no causal order*,“ Nat. Comm **3**, 1092 (2012)
- Nothing quantum / no quantum features!
- Not formulated in the GR language / no specific type of systems (billiard balls, fields, *etc.*)
Instead: Abstract formalism for classical and deterministic dynamics.
- Very subtle CTCs; maybe not what you expect.

CORE ASSUMPTION

Any classical operation that is possible in ordinary space-time should also be possible in the presence of CTCs, as long as the operation takes place in a localized region of space-time that does not contain CTCs.

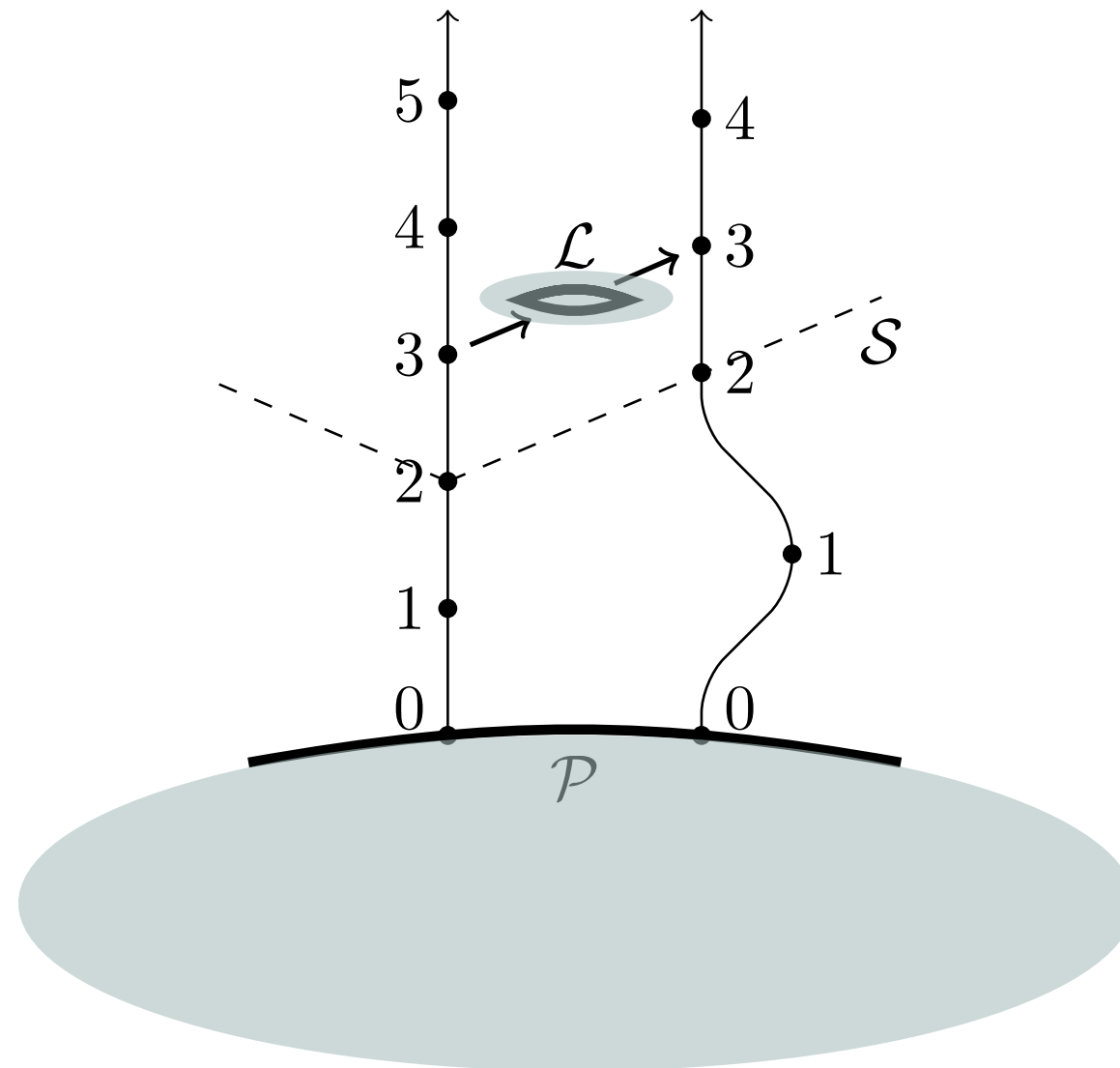

CORE ASSUMPTION

Any classical operation that is possible in ordinary space-time should also be possible in the presence of CTCs, as long as the operation takes place in a localized region of space-time that does not contain CTCs.

Local regions

*N non-overlapping CTC-free space-time regions $(1, 2, \dots, N)$.
Decompose every region R into *future* and *past* boundary.*

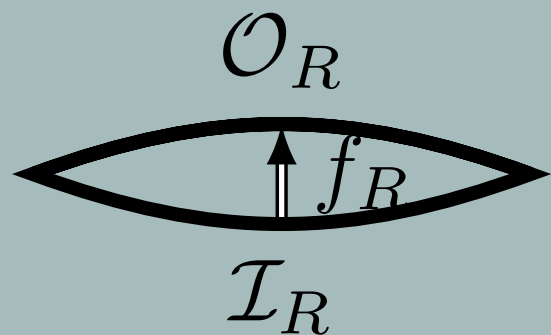

$\mathcal{I}_R, \mathcal{O}_R$ state spaces, e.g., integers, reals
 $f_R : \mathcal{I}_R \rightarrow \mathcal{O}_R$ function on region R

CORE ASSUMPTION

Any classical operation that is possible in ordinary space-time should also be possible in the presence of CTCs, as long as the operation takes place in a localized region of space-time that does not contain CTCs.

Predictive theory

There exists a function w that *predicts* the state on the past boundaries of the local regions.

$$w = (w_1, w_2, \dots, w_N)$$

$$w_R: O_1 \times O_2 \times \dots \times O_N \rightarrow I_R$$

CORE ASSUMPTION

Any classical operation that is possible in ordinary space-time should also be possible in the presence of CTCs, as long as the operation takes place in a localized region of space-time that does not contain CTCs.

Consistency condition

There exists some state (i_1, i_2, \dots, i_N) such that
for every region R :

$$i_R = w_R(o_1, o_2, \dots, o_N) = w_R(f_1(i_1), f_2(i_2), \dots, f_N(i_N))$$

(i_1, i_2, \dots, i_N) is a *fixed point* of the function w .

CORE ASSUMPTION

Any classical operation that is possible in ordinary space-time should also be possible in the presence of CTCs, as long as the operation takes place in a localized region of space-time that does not contain CTCs.

Consistency condition is equivalent to:

Irrelevance on how the local functions (f_1, f_2, \dots, f_N) are implemented.

CORE ASSUMPTION

Any classical operation that is possible in ordinary space-time should also be possible in the presence of CTCs, as long as the operation takes place in a localized region of space-time that does not contain CTCs.

No-new-physics Principle:

Consistency under any choice of local operations:

$$\forall f_1, f_2, \dots, f_N \quad \exists i_1, i_2, \dots, i_N:$$

$$i_R = w_R(f_1(i_1), f_2(i_2), \dots, f_N(i_N)) \text{ for every region } R$$

CORE ASSUMPTION (SUMMARY)

- Non-overlapping space-time regions (CTC-free)
- Classical state spaces (not quantum)
- Deterministic evolution
- Consistency, No-new-physics principle

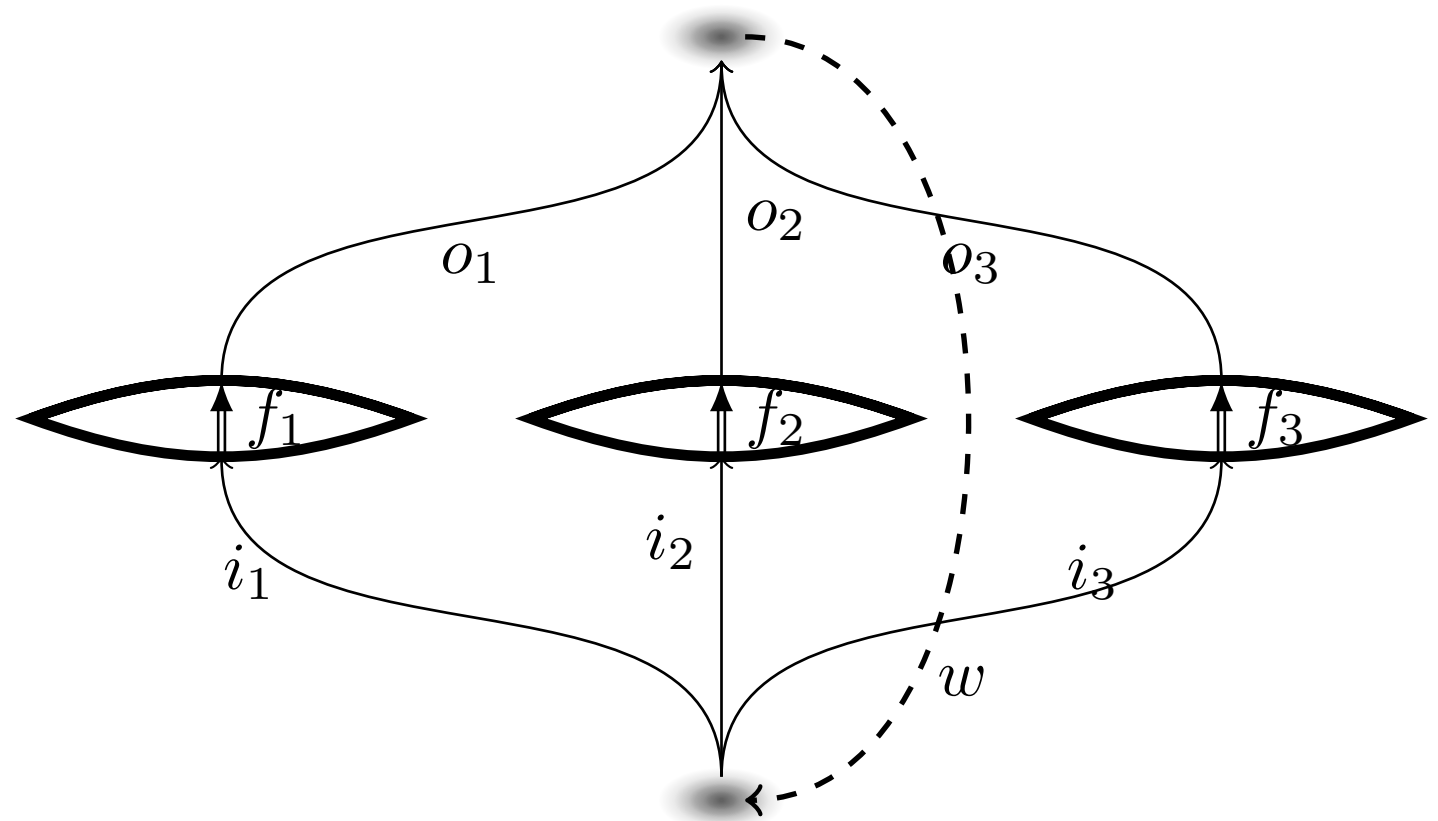

PROPERTIES

- Special case of P-CTC framework
- Unique dynamics (unique fixed points)
- Reversible dynamics
- Computational tameness
- CTCs with three regions or more

PROPERTY: SPECIAL CASE OF P-CTC

- We recover a *special* case of the P-CTC framework.
Namely: the *linear* special case.

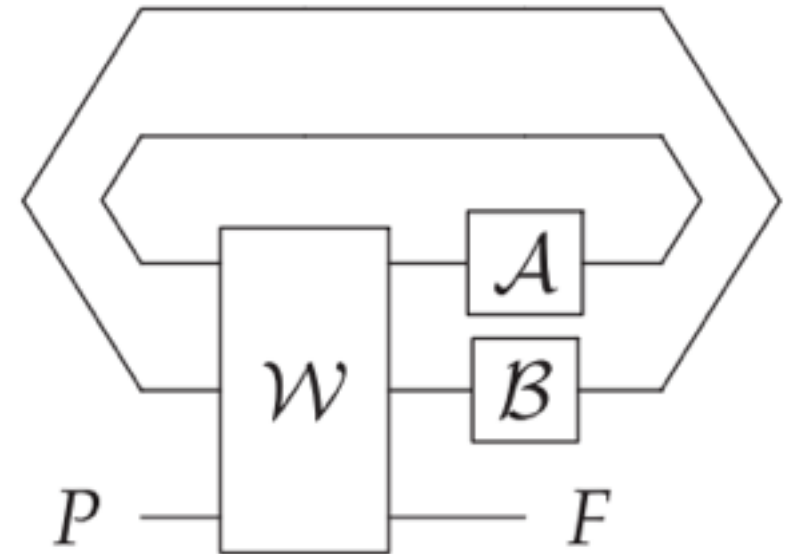

- Here: *Classical* state spaces as opposed to quantum.
- The same can be done for quantum evolution.

PROPERTY: UNIQUE DYNAMICS

► Consistency under any choice of local operations:

$$\forall f_1, f_2, \dots, f_N \quad \exists i_1, i_2, \dots, i_N:$$
$$i_R = w_R(f_1(i_1), f_2(i_2), \dots, f_N(i_N)) \text{ for every region } R$$

implies that the fixed point is **unique**:

$$\forall f_1, f_2, \dots, f_N \quad \exists ! i_1, i_2, \dots, i_N:$$
$$i_R = w_R(f_1(i_1), f_2(i_2), \dots, f_N(i_N)) \text{ for every region } R$$

PROPERTY: UNIQUE DYNAMICS

► Interpretation:

By definition we exclude the „Grandfather antinomy.“

No „unproven theorem“ paradox for free!

The theory gives *unique predictions!*

cesses. In adopting this *evolutionary principle* we reject such antirational doctrines as creationism, and more gen-



PROPERTY: REVERSIBLE DYNAMICS

► Reversibility:

Every function w can be embedded in a *reversible* function w' .

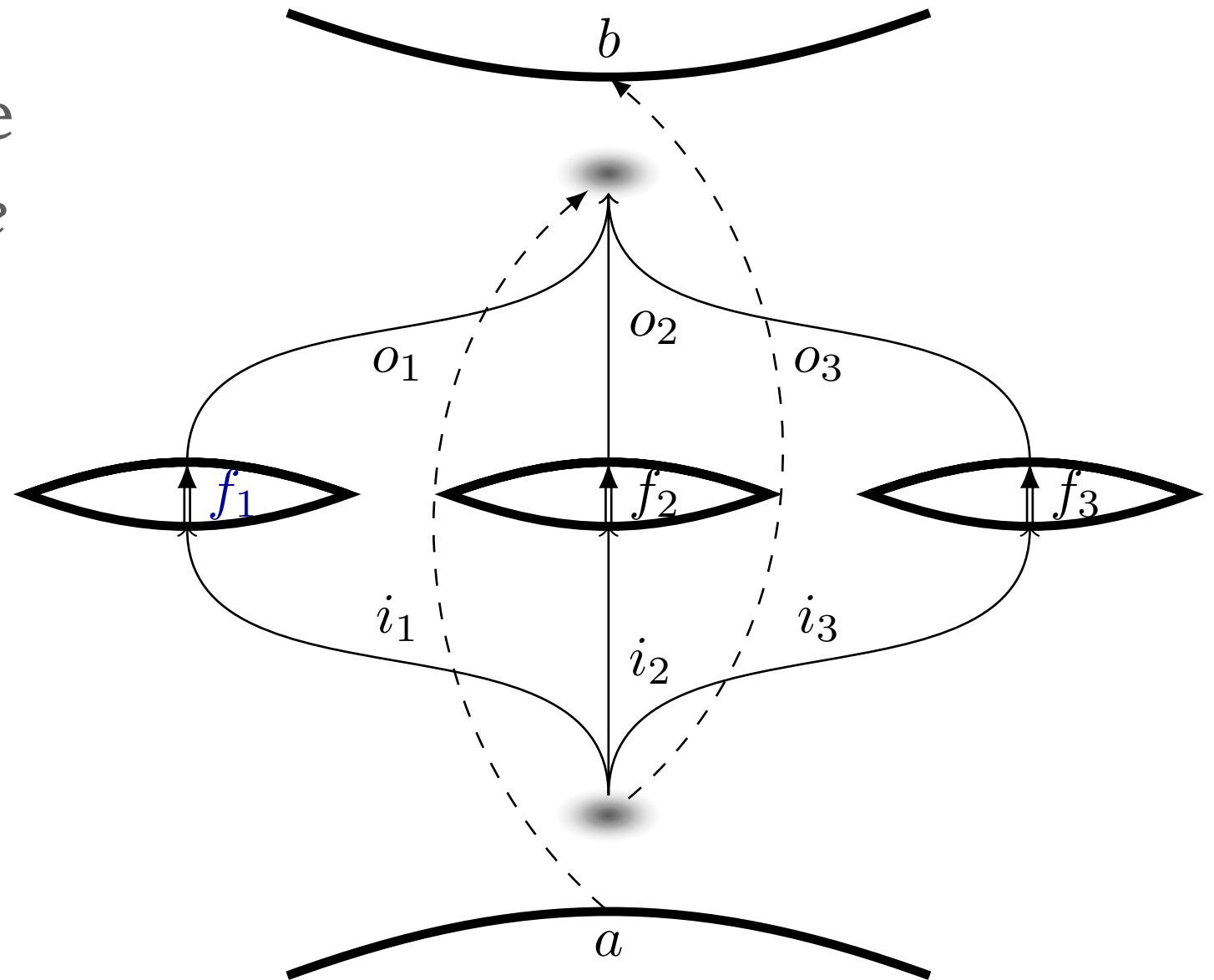

PROPERTY: COMPUTATIONAL TAMENESS

- Computational power:
Upper bounded by $\mathbf{UP} \cap \mathbf{coUP}$,
i.e., cannot* efficiently solve
NP-complete problems.

(*For discrete state spaces and under the assumption
that the polynomial hierarchy does not collapse.)

- Comply with NP-hardness assumption:
Physically realizable models of computation
cannot efficiently solve NP-complete problems.

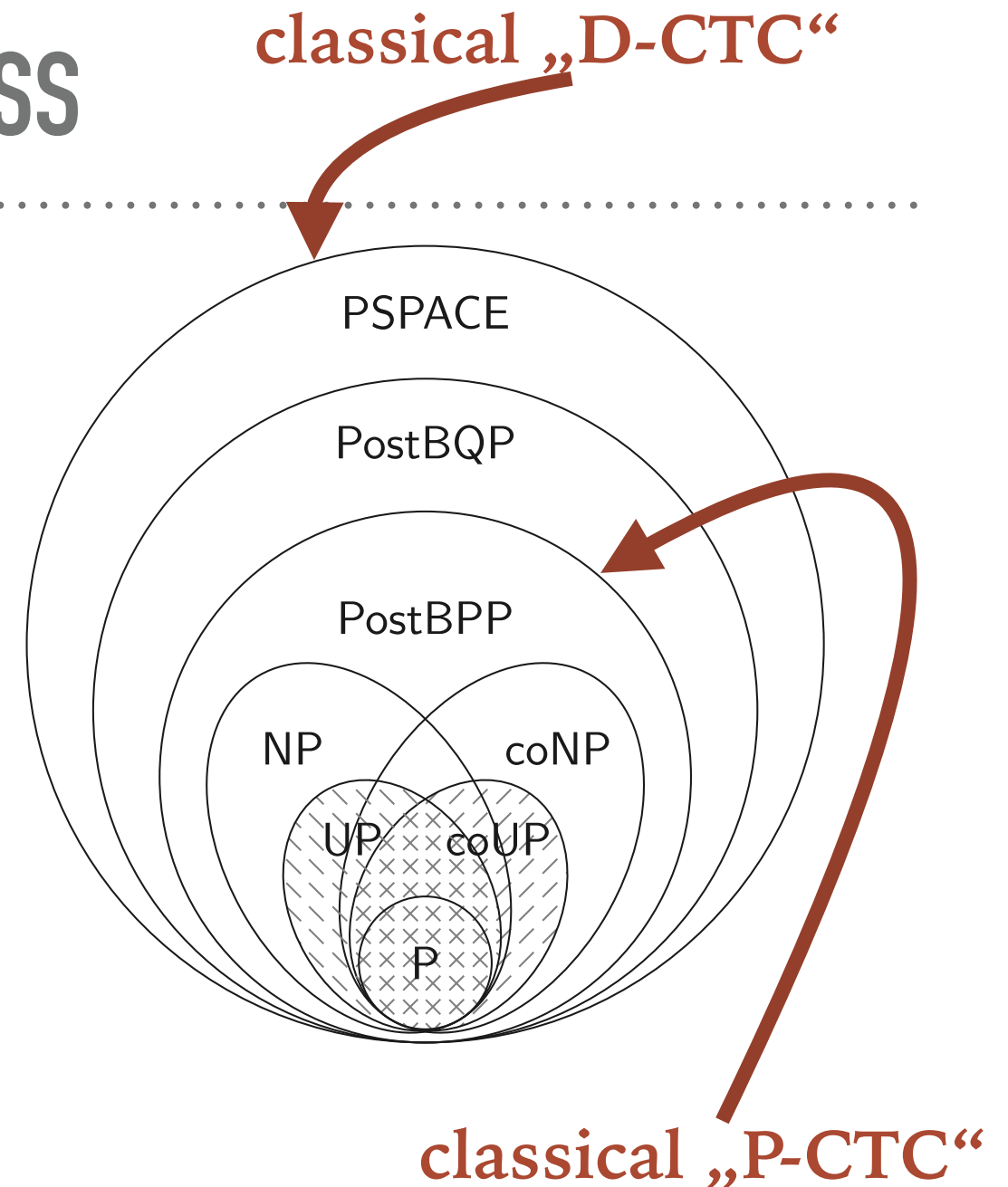

ÄB, S. Wolf, Proc. R. Soc. A 474, 20170698 (2018)
S. Aaronson, ACM SIGACT News 36, 30 (2005)
see also K. Gödel, Letter to von Neumann (1956)

EXAMPLE WITH THREE REGIONS

► Binary state spaces: $\{0,1\}$

► $w: \{0,1\}^3 \rightarrow \{0,1\}^3$

$$w: (a, b, c) \mapsto ((b \oplus 1)c, (c \oplus 1)a, (a \oplus 1)b)$$

\oplus : addition mod 2

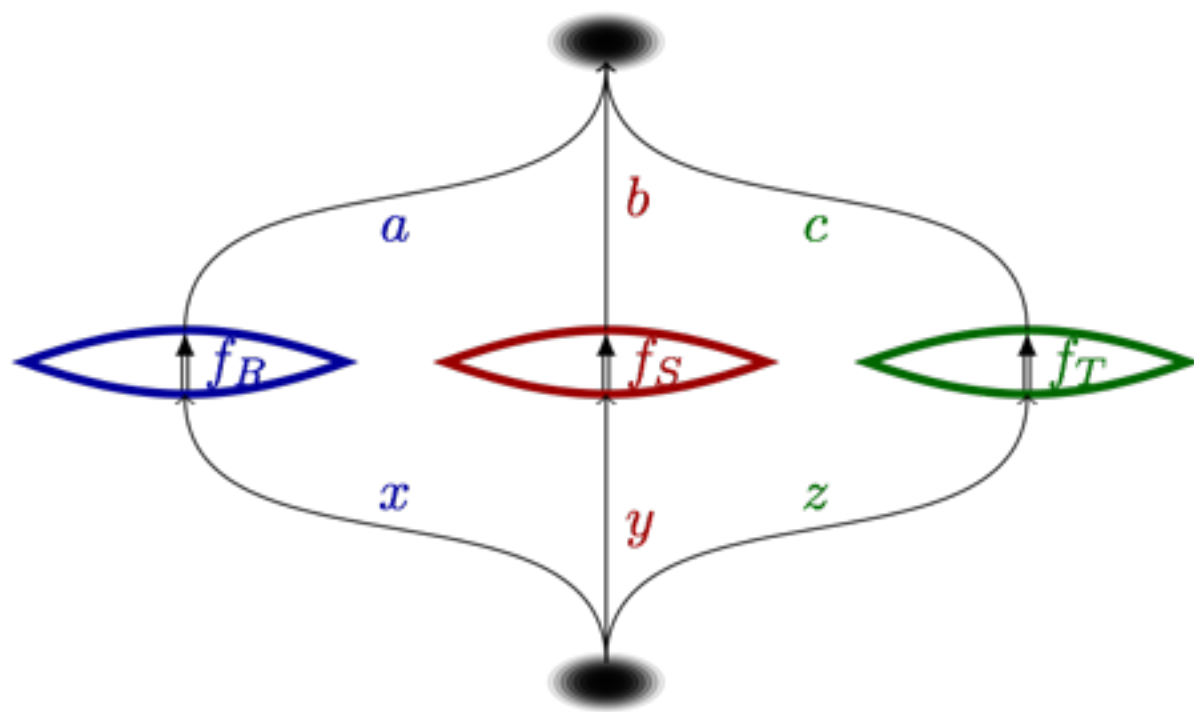

$$\text{maj}(a, b, c) = 0$$

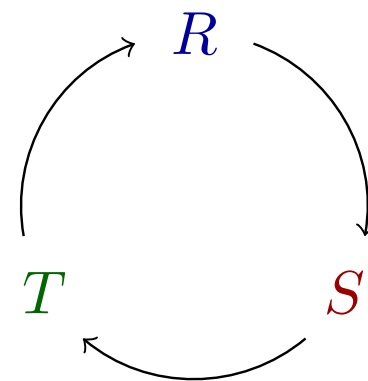

$$\text{maj}(a, b, c) = 1$$

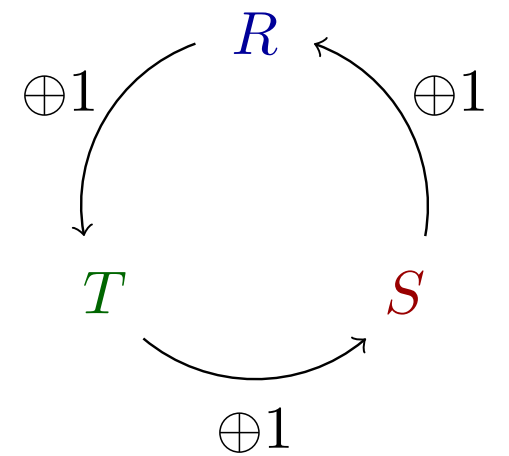

► Can be extended to *reals*, to more parties, and made reversible.

CONCLUSION

- CTC dynamics are possible even if we retain „free choice,“ *i.e.*, the no-new-physics principle.
- Unique dynamics; no „unproven theorem“ paradox
- Reversible dynamic
- Computational tameness;
cannot solve NP-complete problems efficiently
- Ongoing work: Extension to the quantum case.
How many of these properties persist?
Special case (*linear*) of the P-CTC formalism.

GRAZIE MILLE!

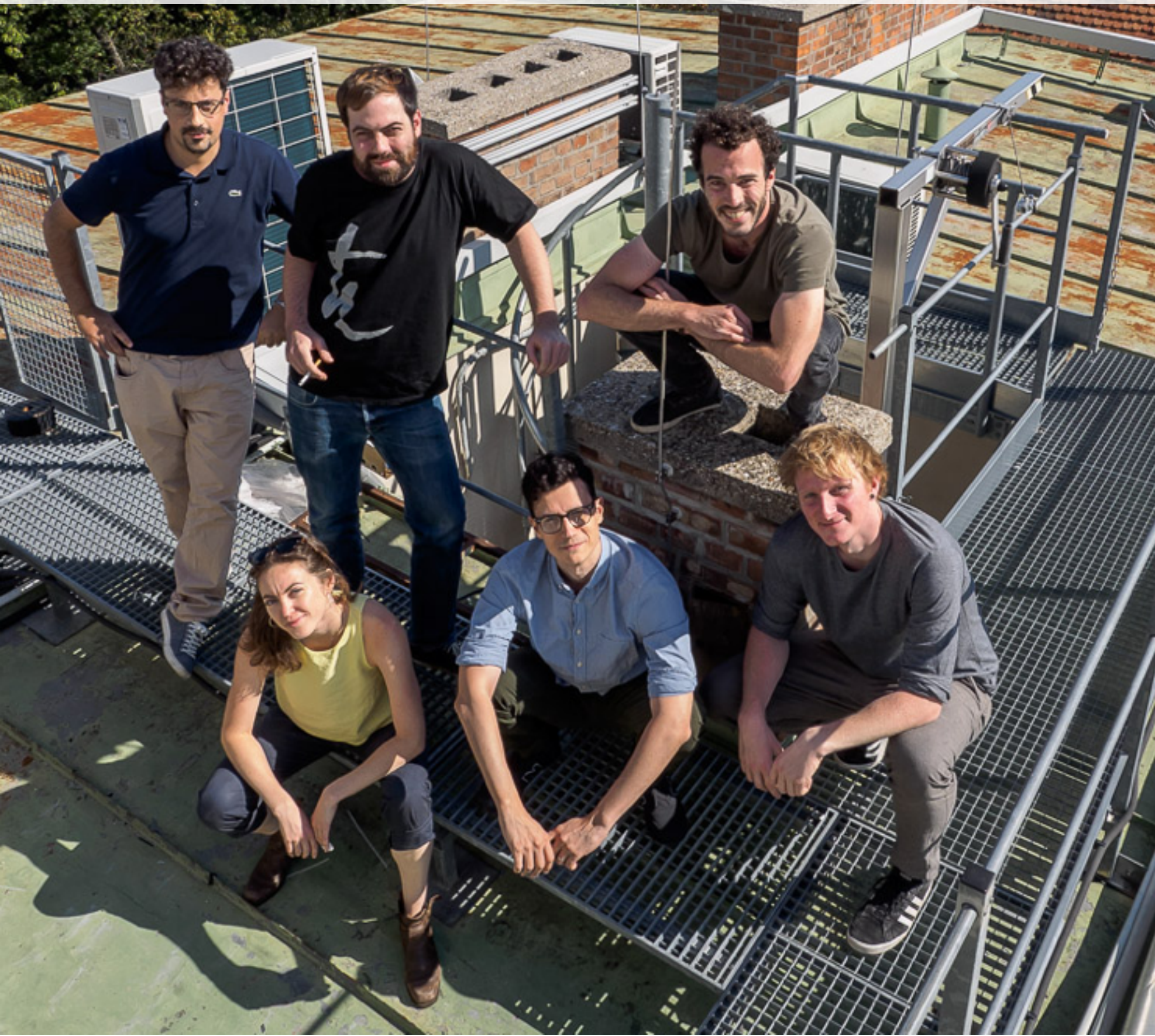

PhD Position
available in the
*„Young Independent
Researcher Group“*

