

CSN5

Forum della Ricerca Sperimentale e Tecnologica in INAF

Bologna, 22-24 Giugno 2022

HW & SW Strumentale (Monitoring & Control)

Electronic Lab @ OAC: Skills, Instrumentations and Know-how

Gianmarco Angius



UNIONE EUROPEA
Fondo Sociale Europeo
Fondo Europeo di Sviluppo Regionale



Ministero dell'Istruzione,
dell'Università e della Ricerca



PON
RICERCA
E INNOVAZIONE
2014 - 2020



People of Electronic Lab @ OAC



Pisanu



Navarrini



Ladu



Schirru



Gaudiomonte



Ortu



Maxia



Angius



Cabras



Marongiu



Melis



Concu

Who I was (before INAF-OAC)



- Attività di ricerca @ UniCA e spin-off TechOnYou S.r.l.
- Percorso dipendente @ Inpeco S.p.a.
- Percorso assegnista di ricerca @ INAF-OAC

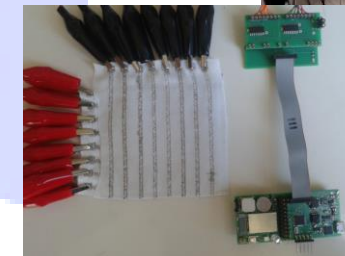
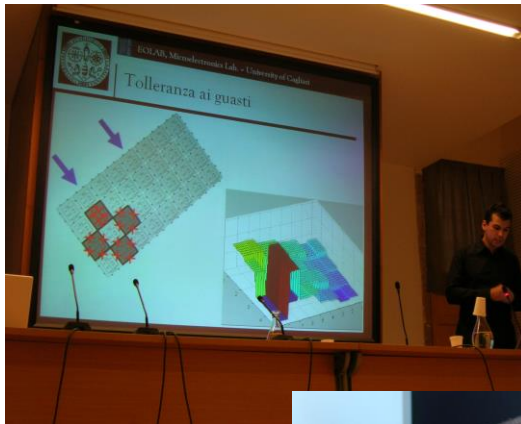

- Attività di ricerca @ UniCA e spin-off TechOnYou S.r.l.
- Percorso dipendente @ Inpeco S.p.a.
- **Percorso assegnista di ricerca @ INAF-OAC**

Assegno di Ricerca dal titolo «Progettazione e realizzazione di schede elettroniche di controllo»

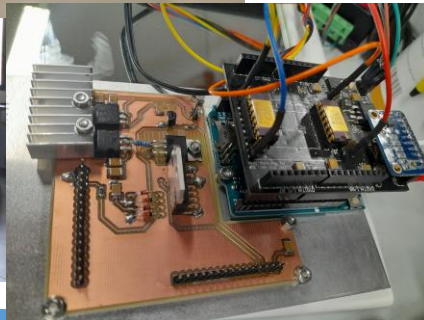

Xilinx RFSoc ZCU216 Evaluation Kit

FW and HDL DEVELOPMENT

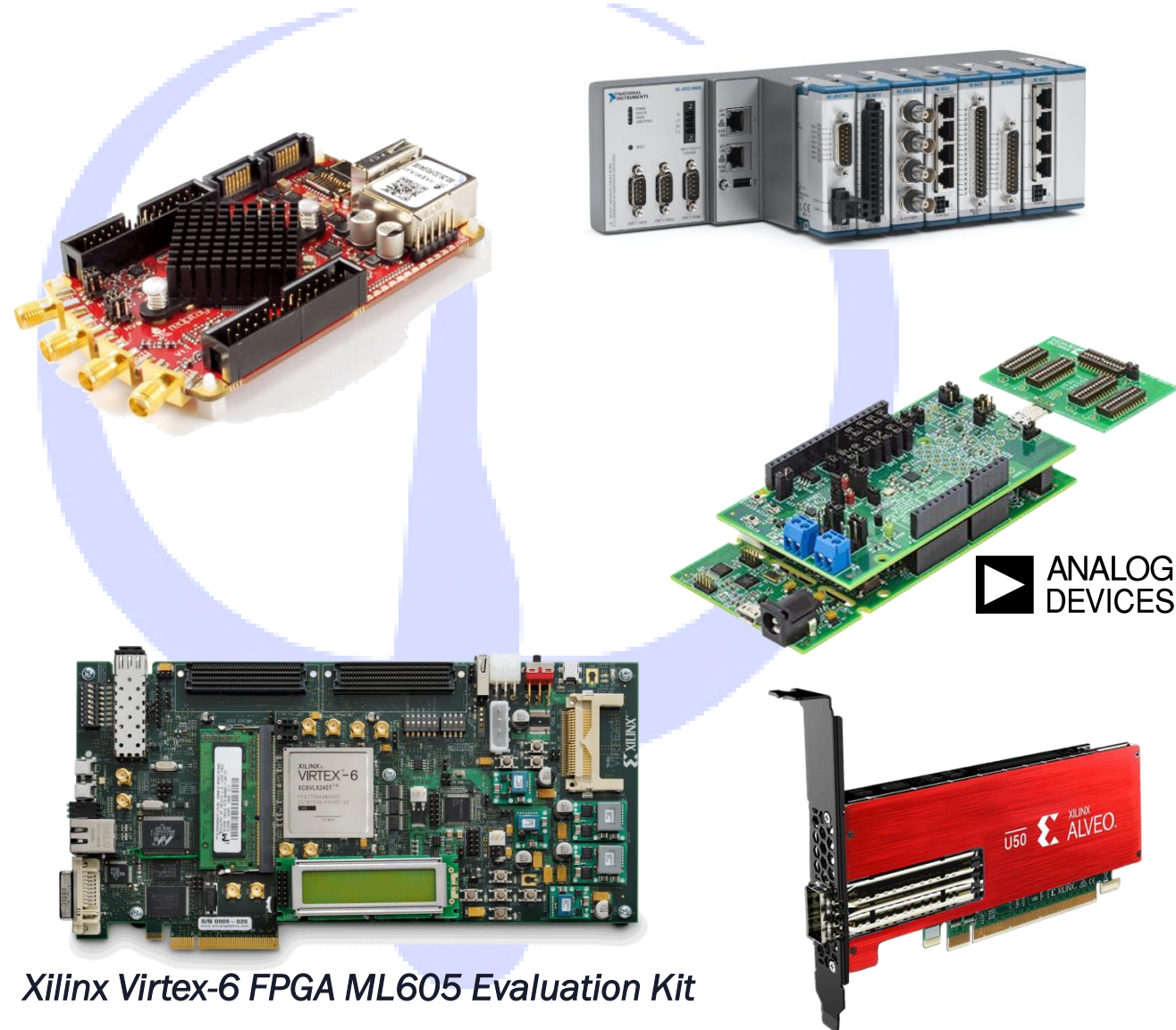

▶ ANALOG
DEVICES

Xilinx Virtex-6 FPGA ML605 Evaluation Kit

The Collaboration for Astronomy
Signal Processing and
Electronics Research

BACKENDS IN PRODUZIONE

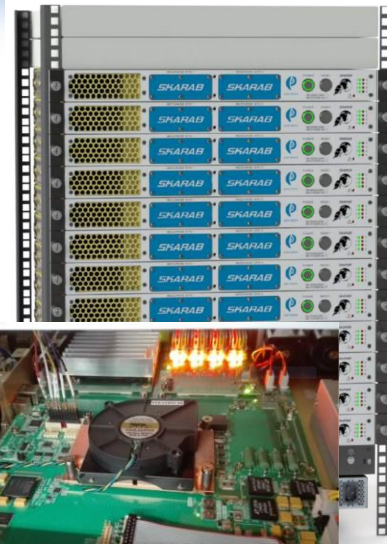

SKARAB
(*Square Kilometer Array
Reconfigurable Application Board*)

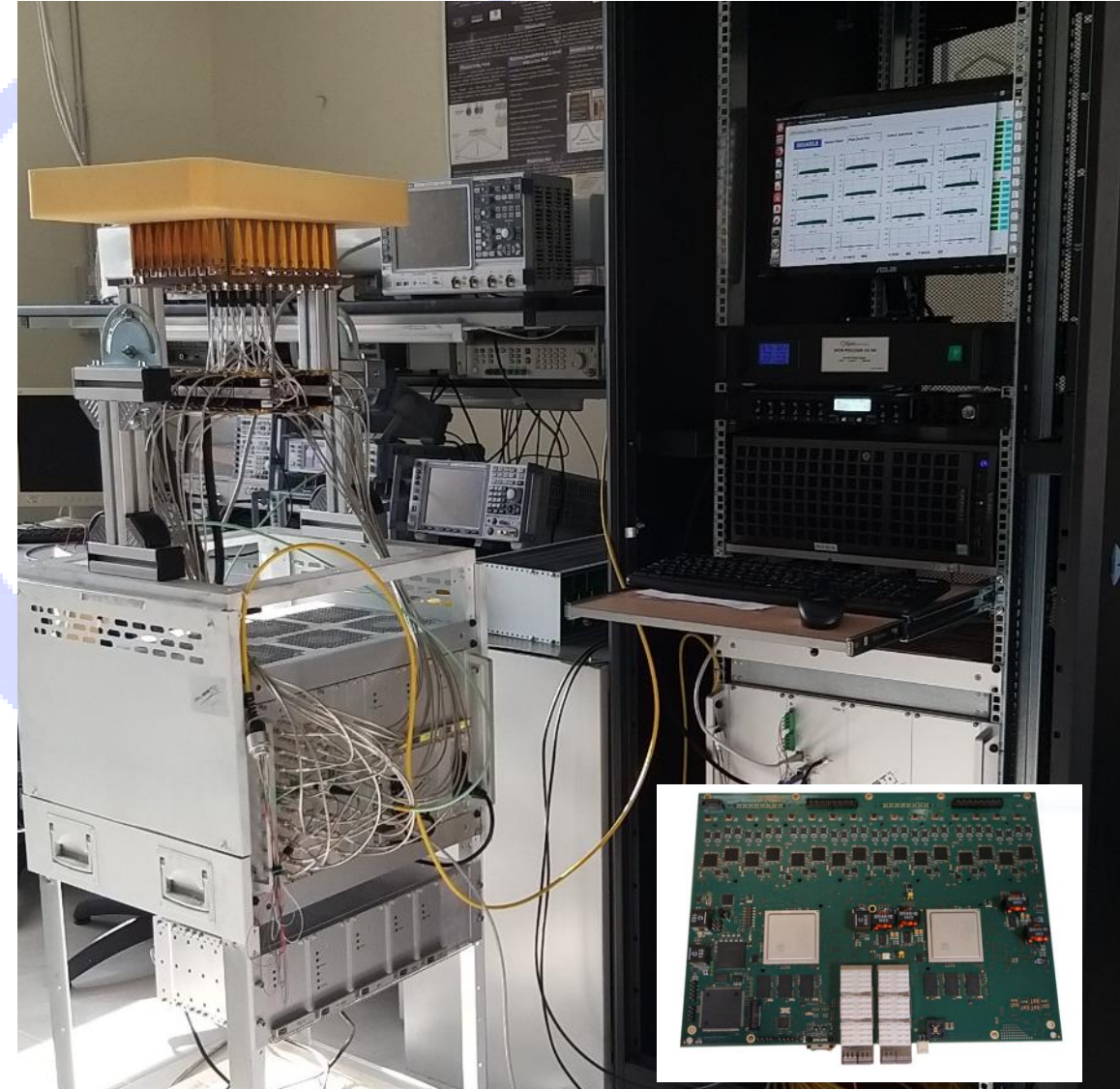

Sistema beamformer per PAF PHAROS2

SARDARA
(*Sardinia Roach2-based Digital Architecture for Radio Astronomy*)



PCB RAPID PROTOTYPING



Bondatrice Kulicke & Soffa



Keyence VHX-7000

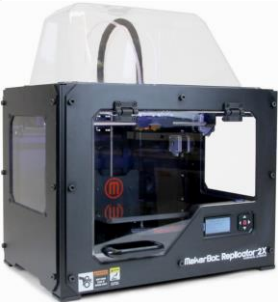
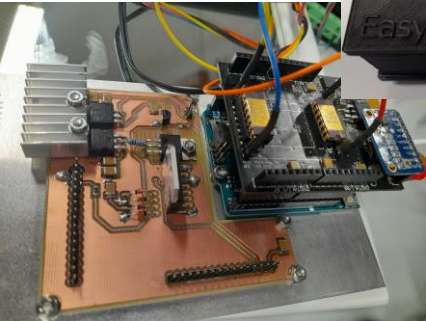

SYSTEM DEBUGGING, TESTING AND MEASUREMENTS

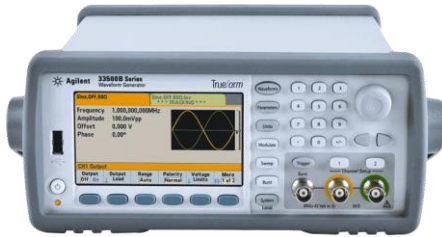

KNOW-HOW ON SYSTEM AND PCB DESIGN



AUTODESK® EAGLE

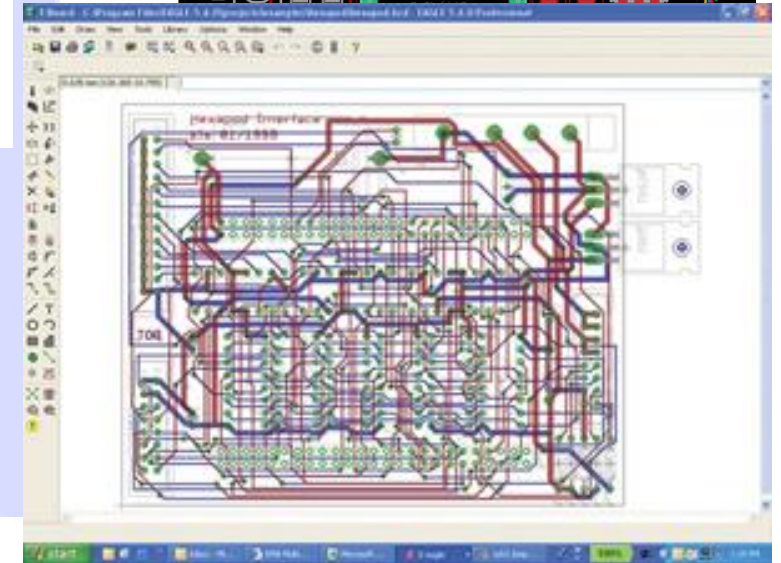
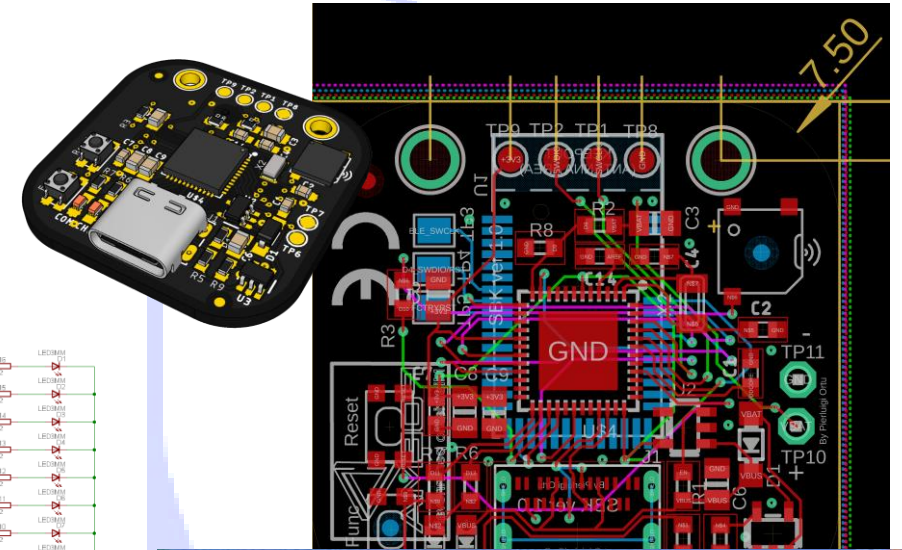
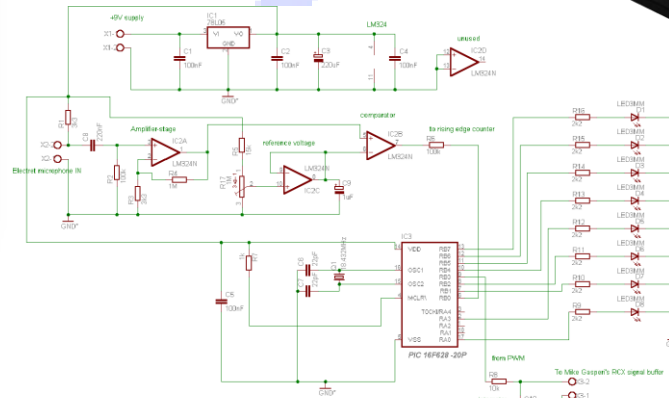

- **Progettazione PCB a bassissime RFI e realizzazione prototipi in-house**
- **CAD progettazione in tutti i lab INAF**
 - **E' possibile uniformare?**
- **Problema condiviso lentezza acquisti minuterie**
 - **Si può trovare una soluzione?**
- **Strategie di approvvigionamento e fornitore produzione**
 - **Si possono condividere strategie e canali?**
- **Progettazione PCB complesse**
 - **E' possibile iniziare un percorso per la condivisione delle competenze?**



CSN5

Forum della Ricerca Sperimentale e Tecnologica in INAF

Bologna, 22-24 Giugno 2022

Thank you for your kind attention!



UNIONE EUROPEA
Fondo Sociale Europeo
Fondo Europeo di Sviluppo Regionale



Ministero dell'Istruzione,
dell'Università e della Ricerca



PON
RICERCA
E INNOVAZIONE
2014 - 2020

